



Clamp Meter Auto range 1000 Amps

SAFETY INFORMATION

The digital clamp meter has been designed according to IEC10101 and IEC10102032 concerning safety requirements for electrical measuring instruments and hand-held current clamps with double insulation over voltage category 1000V CAT II 600V CAT III and pollution 2.

This meter complies with the requirements of the following European Community Directives:



89 / 336 / EEC (Electromagnetic Compatibility) and 73 / 23 / EEC (Low Voltage) as amended by 93 / 68 / EEC (CE Marking).

However, electrical noise or intense electromagnetic fields in the vicinity of the equipment may disturb the measurement circuit.

Measuring instruments will also respond to unwanted signals that may be present within the measurement circuit.

Users should exercise care and take appropriate precautions to avoid misleading.

SYMBOL EXPLANATION

-  Important safety information, refer to the operating manual.
-  Dangerous voltage may be present.
-  Earth ground.

CONTENTS

	PAGE
SAFETY INFORMATION.....	1
SYMBOL EXPLANATION	1
SAFETY PRECAUTIONS.....	2
MAINTENANCE.....	3
GENERAL DESCRIPTION.....	3
PANEL DESCRIPTION.....	3
OPERATING INSTRUCTIONS.....	6
SPECIFICATIONS.....	9
AUTO POWER OFF.....	12
REPLACING THE BATTERY.....	12
ACCESSORIES.....	13

SAFETY PRECAUTIONS

Follow all safety and operating instructions to ensure maximum personal safety during the operation and to ensure the meter is used safely and is kept in good operating condition.

- Read the operating instructions thoroughly and completely before operating your meter. Pay attention to WARNINGS, which will inform you of potentially dangerous procedures. The instructions in these warnings must be followed.
- Always inspect your meter and test leads for any sign of damage or abnormality before every use. If any abnormal conditions exist (i.e. broken test leads, cracked cases, display not reading, etc.), do not attempt to take any measurements.
- Do not expose the instrument to direct sunlight, extreme temperature or moisture.
- Never ground yourself when taking electrical measurements. Keep your body isolated from ground by using dry clothing, rubber shoes, rubber mat or any approved insulating material.
- You always are careful when working with voltages above 60V dc or 30V ac rms. Keep fingers behind the probe barriers while measuring.
- To avoid damages to the instrument, do not exceed the maximum limits of the input values shown in the technical specification tables.
- Never use the meter to measure voltages that might exceed the maximum allowable input value of any function.

MAINTENANCE

- Never touch exposed wiring, connections or any live circuit when attempting to take measurements.
- Before opening the case, always disconnect test leads from all energized circuits.
- Never use the meter unless the back cover is in place and fastened completely.
- Do not use abrasives or solvents on the meter. To clean it using a damp cloth and mild detergent only.
- Qualified and trained service technicians should only perform calibration and repair of the meter.

GENERAL DESCRIPTION

The meter is an autorange professional clamp meter with 5999 counts. For measuring DC and AC voltage, AC current, Resistance, Capacitance, Frequency, ADP, Diode, and Continuity Test with battery operated.

There is the AC measurement to be RMS or TRUE RMS about the meter. It is chosen as user buy.

PANEL DESCRIPTION

1. Transformer jaws

Pick up the AC current flowing through the conductor.

2. Rotary switch

Rotary switch is used to select functions.

3. HOLD button

When this button is pushed, the display will keep the last

reading and “” symbol will appear on the LCD. Pushing it again returns the meter to normal mode.

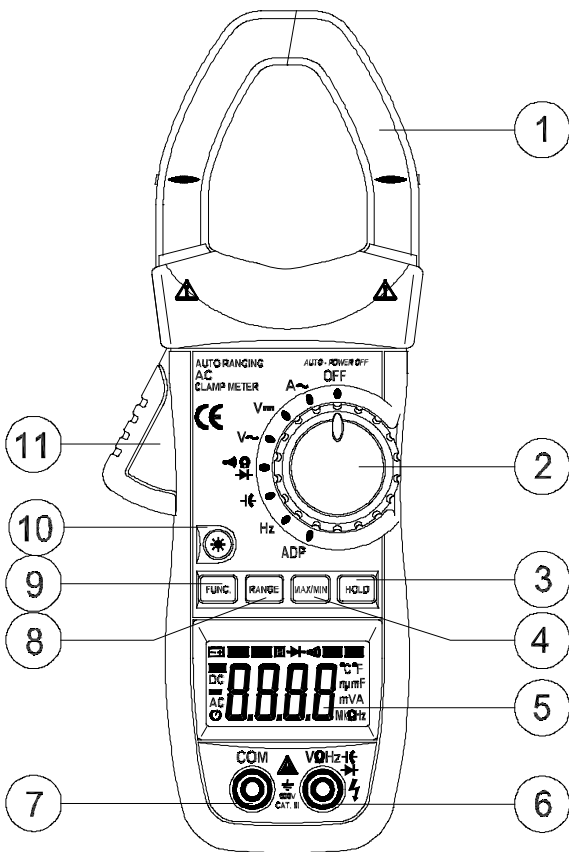

4. MAX/MIN button

Press the button to enter the **MAX/MIN** Recording Hold mode. The maximum, minimum values are then reset to the present input. The readings are stored in memory. “**MAX**” or “**MIN**” annunciator turns on to indicate what value is being displayed. Hold this button for more than 3 seconds to return to the normal operating mode.

5. LCD display

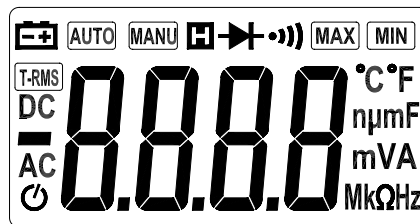

6. “VΩHz” jack

This is positive input terminal for volt, resistance, diode, capacitance frequency, ADP and Continuity test. Connection is made to it using the red test lead.

7. “COM” jack

This is negative (ground) input terminal for all measurements except current.

Connection is made to it using the black test lead.

8. RANGE button

Press this button to select auto and manual range. When a function with auto and manual mode is selected, the meter enters autorange at first. To change to manual range, push this button once.

When the meter operates in manual ranging mode, push this button to change range to the higher one and hold this button for more than 3 seconds to return to auto range mode

9. FUNC. button

In Ω or \rightarrow range, press this button to select Ω or \rightarrow or \rightarrow function. Different symbol of function will appear on the LCD.

10. * button

Press the button is used to turn the backlight on. Press the button again is used to turn the backlight off. To turn the backlight on again, just press it once more.

11. Rigger

Press the lever to open the transformer. When the lever is released, the jaws will close again.

OPERATING INSTRUCTIONS

DC VOLTAGE MEASUREMENT

1. Insert the black and red test leads into the **COM** and **V Ω Hz** input terminals respectively.
2. Set rotary switch at desired V $\overline{\text{---}}$ position.
Connect the test lead tips in parallel with the circuit to be measured. Be careful not to touch any electrical conductors.
3. The polarity of the red lead connection will be indicated along with the voltage value.
4. Read the measure result from the display.

AC VOLTAGE MEASUREMENT

1. Insert the black and red test leads into the **COM** and **V Ω Hz** input terminals respectively.
2. Set rotary switch at desired V \sim position.

Connect the test lead tips in parallel with the circuit to be measured. Be careful not to touch any electrical conductors.

3. Read the measure result from the display.

AC CURRENT MEASUREMENT

1. Set the rotary switch at desired A \sim position.
2. Press the trigger to open transformer jaw and to clamp one conductor only, making sure that the jaw is firmly closed around the conductor.
3. Read the measure result from the display.

RESISTANCE MEASUREMENT

1. Insert the black and red test leads into the **COM** and **V Ω Hz** input terminals respectively.
2. Set rotary switch at desired Ω or \rightarrow position.
Connect the test lead tips in parallel with the resistance in the circuit being measured.
3. Read the measure result from the display.

NOTE:

1. If the resistance being measured exceeds the maximum value of the range or the input is not connected, an overrange indication "OL" will be display.
2. When checking in-circuit resistance, be sure the circuit under test has all power removed and that all capacitors have been discharged fully.

CONTINUITY TESTING

1. Insert the black and red test leads into the **COM** and **V Ω Hz** input terminals respectively.

2. Set rotary switch at desired $\Omega \rightarrow \rightarrow$ position.
3. Push **FUNC.** button to select Ω .
4. Connect the test lead tips in parallel with the resistance in the circuit being measured. If continuity exists (i.e., resistance less than 40Ω) built – in buzzer will sound.

DIODE TESTING

1. Insert the black and red test leads into the **COM** and **V Ω Hz** input terminals respectively.
2. Set rotary switch at desired $\Omega \rightarrow \rightarrow$ position.
3. Push **FUNC.** button to select \rightarrow . The red lead should be connected to the anode and the black lead to the cathode of the diode.
4. The typical voltage drop should be about 0.6V for silicon diode or 0.3V for germanium diode. If the diode is reverse biased or there is an open circuit the reading displayed will be “OL”.

CAPACITANCE MEASUREMENT

1. Insert the black and red test leads into the **COM** and **V Ω Hz** input terminals respectively.
2. Set the rotary switch to \rightarrow position.
3. Connect test leads across the capacitor under measurement and be sure that the polarity of connection is observed. The polarity of the red lead connection is positive “+”.
4. Read the measure result from the display.

FREQUENCY MEASUREMENT

1. Insert the black and red test leads into the **COM** and **V Ω Hz** input terminals respectively.
2. Set the rotary switch to **Hz** position.
3. Connect the test leads across the source or load under measurement. The polarity of the red lead connection is positive “+”.
4. Read the measure result from the display.

NOTE

1. The signal amplitude must also be greater than the sensitivity level.
2. Determine that the amplitude level of the signal to be measured is not greater than the input voltage limit. (10V DC/AC rms)

ADP MEASUREMENT

It is standby for user.

1. Insert the black and red test leads into the **COM** and **V Ω Hz** input terminals respectively.
2. Set the rotary switch to ADP position.
3. DCV \leq 600mV.

SPECIFICATIONS



Accuracy:

$\pm\%$ of reading \pm number of least significant digits at 18°C to 28°C (64.4°F to 82.4°F), with relative humidity up to 75%. All specifications assume less than 1 year since calibration.

Temperature coefficient:

0.1 \times specified accuracy/ $^{\circ}\text{C}/^{\circ}\text{F}$.

GENERAL

Maximum voltage:	1000V CATIII 600V CATIII
Altitude:	2000m
Display:	LCD 5999 counts, Updates 2-3/sec
Ranging method:	Auto/manual range mode
Polarity indication:	"-" display for negative polarity
Overrange indication:	LCD will display "OL"
Low battery:	"  " will appears on LCD
Jaw capability:	40mm,Max conductor size
Power:	Battery 1.5V×3  Size AAA
Size:	225mm×86mm×32mm (8.85x3.38x1.25 inch)
Weight:	Approx. 330g (11.64 Ounces)
Operating:	5°C to 35°C (41°F to 95°F)
Storage temperature:	-10°C to 50°C (14°F to 59°F)

DC VOLTAGE

Range	Resolution	Accuracy
6V	1mV	± (0.8%of rdg +5 digits)
60V	10mV	
600V	0.1V	
1000V	1V	± (1.0%of rdg +5 digits)

Input Impedance: 10MΩ

Overload Protection: 1000V DC or 700V AC RMS

AC VOLTAGE

Range	Resolution	Accuracy
6V	1mV	± (1.2%of rdg +5 digits)
60V	10mV	
600V	0.1V	

750V	1V	± (1.5%of rdg +8digits)
------	----	-------------------------

Input Impedance: 10MΩ

Frequency range: 40Hz to 400Hz

Overload Protection: 1000V DC or 700V AC RMS

AC CURRENT

Range	Resolution	Accuracy
600A	0.1A	± (2.5%of rdg +5 digits)
1000A	1A	± (3.0%of rdg +5 digits)

Frequency range: 50Hz to 60Hz

Overload Protection: 120% ranges for 60 seconds max

RESISTANCE

Range	Resolution	Accuracy
600Ω	0.1Ω	± (1.0% of rdg +3 digits)
6kΩ	1Ω	
60kΩ	10Ω	
600kΩ	0.1kΩ	
6MΩ	1kΩ	
60MΩ	10kΩ	± (5.0% of rdg +8 digits)

Overload Protection: 250V DC or AC rms, ac for all ranges

CAPACITANCE

Range	Resolution	Accuracy
600nF	0.1nF	± (5.0%of rdg +8 digits)
6uF	1nF	
60uF	10nF	± (4.0%of rdg +5 digits)
600uF	0.1uF	
1000uF	1uF	± (5.0%of rdg +8 digits)

Overload Protection: 250V DC or AC rms, ac for all ranges

ADP

Range	Resolution	Accuracy
600mV	0.1mV	± (3.0%of rdg +5 digits)



FREQUENCY

Range	Resolution	Accuracy
40Hz	1Hz	± (0.1% of rdg +1digit)
600Hz	1Hz	
6kHz	1Hz	
60kHz	10Hz	
100kHz	0.1kHz	

Overload Protection: 10V DC or RMS, AC for all ranges

Measurement range: 1V to 10V rms, 40Hz to 100kHz

AUDIBLE CONTINUITY AND DIODE

Range	Description
	If continuity exists (about less than 40 Ω), built-in buzzer will sound.
	Show the approx. Forward voltage of the diode.

AUTO POWER OFF

To extend the battery life, Auto Power Off function is provided. If no key operations of range changing happen about 10 minutes, the meter will be turned off automatically. To turn it on, pushing the **FUNC.** Button only.

REPLACING THE BATTERY



WARNING

To avoid electrical shock or personal injury, remove the test leads and any input signals before replacing the battery. Replace only with same type of battery.

When the electrical tester displays the “” mark or the backlight be not very lit, the battery must be replaced to maintain proper operation. Use the following procedure to replacing the battery:

1. The Rotary Switch is used to select OFF. Disconnect test leads from any live source and remove the test leads from the input terminals.
2. Remove screws on the battery cover and open the cover.
3. Remove the exhausted battery and replace with three new 1.5V size AAA batteries.

Place battery cover and secure by a screw.



CAUTION

Using this appliance in an environment with a strong radiated radio-frequency electromagnetic field (approximately 3V/m) may influence its measuring accuracy.

ACCESSORIES

- Operator's instruction manual
- Set of test leads
- Gift box
- Battery 1.5V×3  Size AAA

Sifam Tinsley Instrumentation Ltd

1 Warner Drive, Springwood Industrial Estate, Braintree, Essex CM7 2YW

Contact No. : +44 (0) 1376 335271

[Email: sales@sifamtinsley.com](mailto:sales@sifamtinsley.com)

www.sifamtinsley.co.uk
