



Volt/mA Calibrator

Safety Information

To avoid possible electric shock or personal injury:

- Never apply more than 30V between any two jacks, or between any jack and earth ground.
- Make sure the battery door is closed and latched before you operate the calibrator.
- Remove test leads from the calibrator before you open the battery door.
- Do not operate calibrator if it is damaged.
- Do not operate the calibrator around explosive gas, vapor, or dust.

To avoid possible damage the calibrator:

- Make sure choose the right jack and rang, before use the calibrator to measurement or calibrator.

- Take away the calibrator from the used circumstance, before operate the calibrator or after close the calibrator.

Introduction

Volt/mA Calibrator is a source and measurement tool. This Calibrator is use to measure or output 0 to 24 mA DC current loop, and 0 to 20 V DC voltage. But the calibrator cannot be used to measurement and source simultaneously.

Volt/mA Calibrator include this accessories: Holster, a pair of Test Leads, AAA*6 battery, and this manual.

If the calibrator is broken or short of some accessories, please contact the supplier. Please contact the distributor about other accessory's information.

The following table has showed the technical parameter and function of

the Calibrator.

Measurement and output voltage parameter

Function	Range	Resolution
DC V mV Input	0 ~ 100 mV	0.01 mV
	0 ~ 20 V	0.001 V
DC V mV Output	0 ~ 100 mV	0.01 mV
	0 ~ 20 V	0.001 V

Volt/mA Calibrator Manual

Loop Power Output	24V DC	N/A
--------------------------	---------------	------------

Measurement and output mA parameter

Function	Range	Resolution
-----------------	--------------	-------------------

Volt/mA Calibrator Manual

DC mA Input	0 ~ 24 mA	0.001 mA
DC mA Output	0 ~ 24 mA	0.001 mA

Specification

Specification are based on a one year calibration cycle and apply from +18°C to +28°C/ 64.4°F to 82.4°F unless stated otherwise. "Counts" means number of increments or decrements of the least significant digit.

DC V Input and Output

Range	Resolution	Accuracy \pm(% of reading + Counts)
100 mV	0.01 mV	0.02 % + 3
20 V	0.001 V	0.02 % + 3
Input impedance:	2M Ω	(nominal), < 100pF
Over voltage protection:	30 V	
Voltage driver capability:	1 mA	

DC mA Input and Output

Range	Resolution	Accuracy \pm(% of reading + Counts)
24 mA	0.001mA	0.015 % + 3

Overload protection: 125 mA, 250V fast acting fuse
Percent display: 0%=4mA, 100%=20mA
Source mode: When output more than 15mA @500 Ω , change the power supply to external power.
The max load is 24mA @700 Ω , when use external power.
Simulate mode: External loop voltage requirement: 24V nominal, 30V maximum, 12V minimum.

LOOP POWER

24 V \pm 10%

General Specifications:

Maximum voltage applied between any jack and earth ground or between any tow jack: 30V

Storage temperature: $-40^{\circ}\text{C}\sim 60^{\circ}\text{C}$ / $-40^{\circ}\text{F}\sim 140^{\circ}\text{F}$

Operating temperature: $-10^{\circ}\text{C}\sim 55^{\circ}\text{C}$ / $14^{\circ}\text{F}\sim 131^{\circ}\text{F}$

Operating altitude: 3000 meters maximum

Temperature coefficient: $\pm 0.005\%$ of range per $^{\circ}\text{C}$ / $^{\circ}\text{F}$ for the temperature range
 -10°C to 18°C (14°F to 64.4°F) and 28°C to 55°C
(82.4°F to 131°F)

Relative humidity: 95% up to 30°C (86°F), 75% up to 40°C (104°F), 45% up to 50°C (122°F), 35% up to 55°C (131°F)

Shock: Random 2g , 5Hz to 500Hz

Safety: 1 meter drop test



Power requirements: AAA*6

Size (LxWxH): 204×99×46 (8.03×3.89×1.81)

Weight: 460g (16.226 Ounces) (include battery)

International Symbols

Volt/mA Calibrator Manual

Symbol	Meaning
	Earth ground
	Conforms to European Union directives
	Refer to this instruction sheet for information about this feature.

Explanation on Front Panel

The front panel is show as in right figure

1. Loop power 24V to ground
2. mA measurement input jack

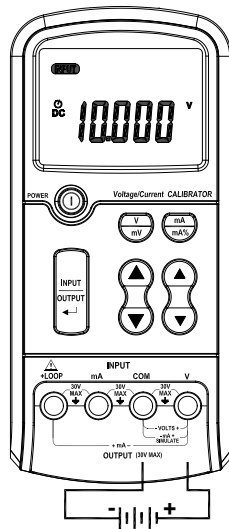

Volt/mA Calibrator Manual

3. Input or output negative (ground) jack
4. V、mV input or output jack
5. Power switch
6. V mV conversion key
7. mA mA% conversion key
8. Input/output conversion key
9. Increase more value key
10. Reduce more value key
11. Increase less value key
12. Reduce less value key

Understanding Display Screen

LCD screen is shown as in following figure

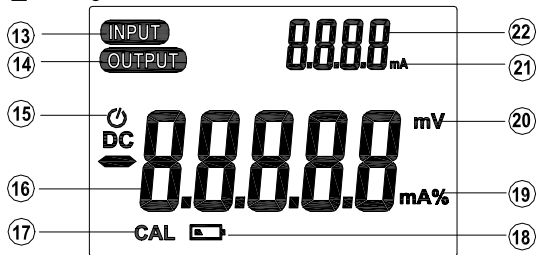

- 13. Input state indication
- 14. Output state indication
- 15. Indicating AUTO POWER OFF is available
- 16. Result value
- 17. Indication to the calibration mode

- 18. Low power indication
- 19. Current mA mA% indication
- 20. Voltage V mV indication
- 21. Current mA indication
- 22. Sub-display zone

Operation Instructions

DC V measurement

- ① Press the power switch **5**, turn on the Calibrator.
- ② Press the input/output conversion key **8**, when the state of no input indicator **13**. Make it under the state of measurement.
- ③ Press the V mV conversion key **6**, make it indicate VDC or mVDC **20**, at the range of measure you need.
- ④ Put the red test lead in V jack **4**, black one to the COM jack **3**.
- ⑤ Connect the red test lead with the positive of voltage which is waiting for measurement, black one to the negative(ground).
- ⑥ The value of result show **16**.

* The number in the **□**, referring to the Explanation on Front Panel (Page9) and the Understanding Display Screen(Page10).

Volt/mA Calibrator Manual

DC V output

- ① Press the power switch **5**, turn on the Calibrator.
- ② Press the input/output conversion key **8**, when the state of no output indicator **14**. Make it under the state of output.
- ③ Press the V mV conversion key **6**, make it indicate VDC or mVDC **20**, at the range of output you need.
- ④ Press the value adjust key **9** **10** **11** **12**, make the value you want.
- ⑤ Put the red test lead in V jack **4**, black one to the COM jack **3**.
- ⑥ Connect the red test lead with the positive of voltage which is waiting for measurement, black one to the negative(ground).
- ⑦ If you want to change the output value or range, then press the value adjust key **9** **10** **11** **12** or the V mV conversion key **6**.

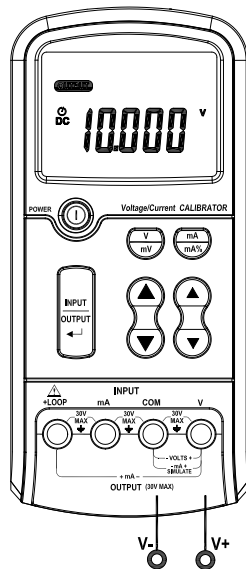

Volt/mA Calibrator Manual

DC mA measurement

Outside supply power measurement

- ① Press the power switch **5**, turn on the Calibrator.
- ② Press the input/output conversion key **8**, when the state of no input indicator **13**. Make it under the state of measurement.
- ③ Press the mA mA% conversion key **7**, make it indicate mA or mA% **19**, at the state of measure you need. In the state of mA% measurement, 4-20mA will be displayed on the sub-display zone **22**.
- ④ Put the red test lead in mA jack **2**, black one to the COM jack **3**.
- ⑤ Connect the red test lead with the positive of current which is waiting for measurement, black one to the negative(ground).
- ⑥ The value of result show **16**.

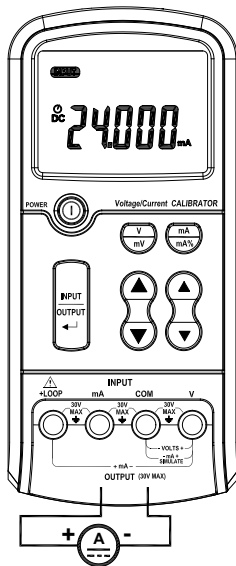

Volt/mA Calibrator Manual

Calibrator supply Loop power measurement

- ① Press the power switch **5**, turn on the Calibrator.
- ② Press the input/output conversion key **8**, when the state of no input indicator **13**. Make it under the state of measurement.
- ③ Press the mA mA% conversion key **7**, make it indicate mA or mA% **19**, at the state of measure you need. In the state of mA% measurement, 4-20mA will be displayed on the sub-display zone **22**.
- ④ Put the red test lead in LOOP jack **1**, black one to the mA jack **2**.
- ⑤ Connect the red test lead with the in of current which is waiting for measurement, black one to the out of current.
- ⑥ The value of result show **16**.

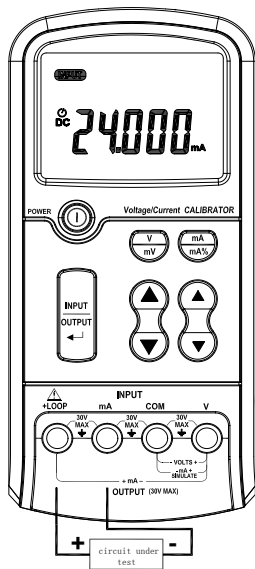

Volt/mA Calibrator Manual

DC mA output

Sourcing mA

- ① Press the power switch **5**, turn on the Calibrator.
- ② Press the input/output conversion key **8**, when the state of no output indicator **14** . Make it under the state of output.
- ③ Press the mA mA% conversion key **7**, make it indicate mA or mA% **19**, at the state of output you need. In the state of mA% output, 4-20mA will be displayed on the sub-display zone **22**.
- ④ Press the value adjust key **9** **10** **11** **12**, make the value on you want.
- ⑤ Put the red test lead in LOOP jack **1**, black one to the V jack **4**.
- ⑥ Connect the red test lead with the positive of current which is waiting for output, black one to the negative.
- ⑦ If you want to change the output value or state, then press the value adjust key **9** **10** **11** **12** or the mA mA% conversion key **7**.

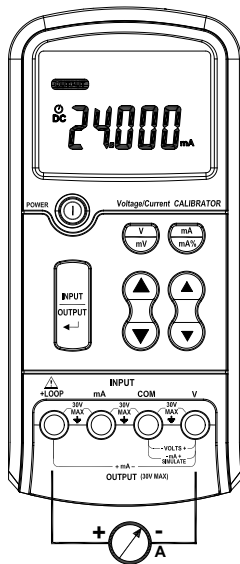

Volt/mA Calibrator Manual

Simulating a Transmitter

- ① Press the power switch **5**, turn on the Calibrator.
- ② Press the input/output conversion key **8**, when the state of no output indicator **14** . Make it under the state of output.
- ③ Press the mA mA% conversion key **7**, make it indicate mA or mA% **19**, at the state of output you need. In the state of mA% output, 4-20mA will be displayed on the sub-display zone **22**.
- ④ Press the value adjust key **9 10 11 12**, make the value you want.
- ⑤ Put the red test lead in V jack **4**, black one to the COM jack **3**.
- ⑥ Connect the red test lead with the positive of power which is outside, black one to the positive of current which is waiting test.
- ⑦ If you want to change the output value or state, then press the value adjust key **9 10 11 12** or the mA mA% conversion key **7**.

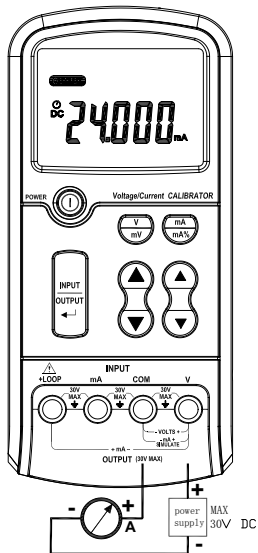

Autopower OFF

Autopower off default setting is 30min.

Setting Autopower off option:

1. Keep press **7** mA mA% conversion key, then turn on the power.
2. Release **7** mA mA% conversion key, press **9** Increase more value key or **10** Reduce more value key to adjust the time.(off,15min.~60min.)
3. Then press **7** mA mA% conversion key to finish setting autopower off option.

*. After change battery the autopower off setting get to default setting.

*. If change battery and found can not turn on power, please take off the battery, and wait 3min, then try again.

Display all symbol

Setting display all symbol:

1. Keep press **6** V mV conversion key, then turn on the power.
2. It will display all symbol on LCD.
3. Press any key exit and go on.

Volt/mA Calibrator Manual

Terminal circuit diagram

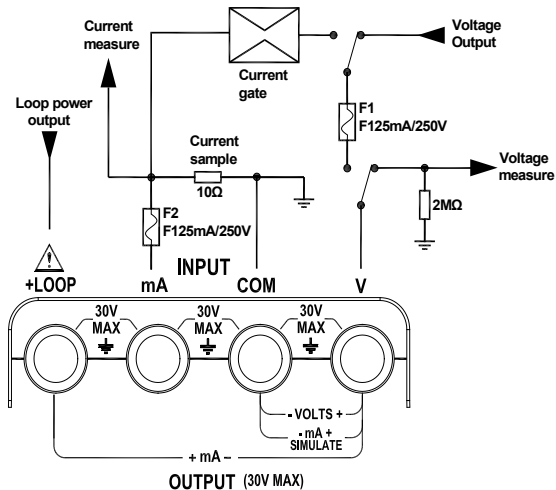

To use Adapter (Only apply to AC power adapter version calibrator)

Connecting the power adapter:

- 1, Connect the AC power cord to the AC—DC converter.
- 2, Plug the AC power cord into an electrical outlet (100V-240V).
- 3, Plug the DC power plug of the converter into DC power socket of the meter.

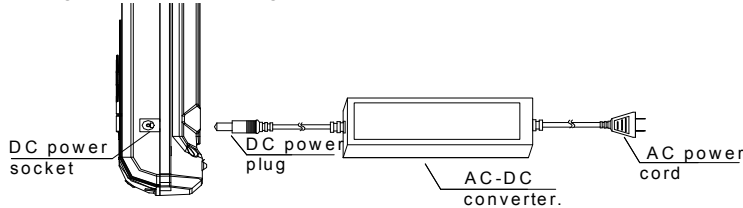

AC/DC adapter information:

Input: 100V-240VAC,50-60Hz 1.8A

Output :DC 12V  2A MAX

Polarity : 

Volt/mA Calibrator Manual

WARNING:

- 1, Please use the original AC power adapter, using other AC power adapter may damage your instrument.
- 2, The AC power adapter can only be used indoors.
- 3, Please plug the AC power cord into an electrical outlet first and then firmly insert DC plug into DC input end in the right of the meter. When unplugged, firstly pull out the DC plug perpendicular to DC input end and then unplug the AC plug from the electrical outlet.
- 4, Do not use the AC power adapter in other equipment except this instrument.
- 5, In use, it is a normal phenomenon that the AC power adapter will be hot.
- 6, Do not demolish the AC power adapter. Otherwise, it may be dangerous.
- 7, Do not use the AC power adapter in a high temperature or wet place.
- 8, Please make the AC power adapter avoid a strong bump.
- 9, It is normal when the AC power adapter make some noise in use.

Maintenance

Cleaning

Periodically wipe the case with a damp cloth and detergent; do not use abrasives or solvents.

Calibration

Calibrate your calibrator once a year to ensure that it performs according to its specifications.

Replacing the Battery

Please change the battery when the LCD indicates 

Turn off the power of the Calibrator, When you change the battery, and screw off the breechblock on the battery cabinet cover, then take off it and instead the fresh battery.

Replacing a Fuse

 **Warning!**

To avoid personal injury or damage to the calibrator, use only a 0.125A 250V fast fuse.

Fuse 1 is probably blown if:

- . In the V output mode, with the test leads removed from the calibrator, the display flashes OL.

Fuse 2 is probably blown if:

- . In the mA input mode, the calibrator always reads 0.000, even with a signal applied.

Sifam Tinsley Instrumentation Ltd

1 Warner Drive, Springwood Industrial Estate,
Braintree, Essex CM7 2YW

Contact No. : +44 (0) 1376 335271

[Email: sales@sifamtinsley.com](mailto:sales@sifamtinsley.com)

www.sifamtinsley.co.uk
